

Triple Power Lithium-ion Battery

User Manual

50 Ah, 72 Ah



SolaX Power Network Technology (Zhejiang) Co., Ltd.

Add.: No. 288, Shizhu Road, Tonglu Economic Development Zone, Tonglu City,
Zhejiang Province, 310000 P.R. CHINA
Tel.: +86 (0) 571-5626 0011
E-mail: info@solaxpower.com

Copyright © SolaX Power Technology (Zhejiang) Co., Ltd. All rights reserved.
No part of this document may be reproduced or transmitted in any form or by any means without
prior written consent of SolaX Power Technology (Zhejiang) Co., Ltd. (hereinafter referred to as
SolaX). SolaX reserves the right of final interpretation.

320101039004

www.solaxpower.com

CHANGE FISTORY

Changes between document versions are cumulative. The latest version contains all updates made in previous versions.

Version 04 (Aug. 21, 2023)

- Updated 3.3 Specifications (Changed the storage temperature)
- Updated 5.2 Installation Mode (Optimized installation steps)
- Updated 9 Maintenance

Version 03 (Mar. 20, 2023)

- Updated 4.4.3 Accessories (Deleted a power cable)

Version 02 (Feb. 25, 2023)

- Updated 2.1.2 Explanation of Symbols (Modified TUV ICON)
- Updated 3.3 Specifications (Modified the value)
- Updated 4.4.3 Accessories (Added a power cable)

Version 01 (May. 30, 2022)

- Updated 4.4.3 Accessories (Modified the info about accessories)
- Updated 5.2.2 Cabinet Installation (Modified the installation steps)
- Updated 6.1 DIP Switch (Added the part)
- Updated 6.3 Status Indicators (Modified info about indicators)

Version 00 (Oct. 25, 2021)

- Initial release

Contents

1	NOTE ON THIS MANUAL.....	1	5	EQUIPMENT INSTALLATION.....	22
1.1	SCOPE OF VALIDITY	1	5.1	INSTALLATION ENVIRONMENT REQUIREMENTS	22
1.2	TARGET GROUP	1	5.2	INSTALLATION MODE	22
1.3	SYMBOLS.....	1	5.2.1	RACK INSTALLATION	22
2	SAFETY 2		5.2.2	CABINET INSTALLATION	32
2.1	SAFETY INSTRUCTIONS	2	6	COMMISSIONING	44
2.1.1	GENERAL SAFETY PRECAUTIONS.....	2	6.1	DIP SWITCH	44
2.1.2	EXPLANATION OF SYMBOLS.....	3	6.2	COMMISSIONING.....	45
2.2	RESPONSE TO EMERGENCY SITUATIONS.....	4	6.3	STATUS INDICATORS.....	48
2.2.1	LEAKING BATTERIES.....	4	6.3.1	BMS (TBMS-MCR0800)	48
2.2.2	FIRE	4	7	TROUBLESHOOTING	49
2.2.3	WET BATTERIES AND DAMAGED BATTERIES	5	7.1	TROUBLESHOOTING	49
2.3	QUALIFIED INSTALLER.....	5	8	DECOMMISSIONING	53
3	PRODUCT INTRODUCTION	6	8.1	DISMANTLING THE BATTERY	53
3.1	PRODUCT OVERVIEW.....	6	8.2	PACKING.....	53
3.1.1	DIMENSIONS AND WEIGHT	6	9	MAINTENANCE	54
3.1.2	INSTALLATION SPACE	9	10	DISCLAIMER.....	55
3.1.3	APPEARANCE	10	*	WARRANTY REGISTRATION FORM	
3.2	BASIC FEATURES.....	12			
3.2.1	FEATURES.....	12			
3.2.2	CERTIFICATIONS	12			
3.3	SPECIFICATIONS.....	13			
3.3.1	T-BAT-SYS-HV-R2.5.....	13			
3.3.2	T-BAT-SYS-HV-R3.6.....	15			
4	PREPARATION BEFORE INSTALLATION	17			
4.1	INSTALLATION PREREQUISITES	17			
4.2	SAFETY GEAR.....	18			
4.3	TOOLS	18			
4.4	PREPARATION.....	18			
4.4.1	CHECK FOR TRANSPORT DAMAGE.....	18			
4.4.2	UNPACKING.....	19			
4.4.3	ACCESSORIES	20			

1 Note on this Manual

1.1 Scope of Validity

This manual is an integral part of the T-BAT Series. It describes the assembly, installation, commissioning, maintenance and failure of the product. Read it carefully before operation.

T-BAT-SYS-HV-R2.5/T-BAT-SYS-HV-R3.6 BMS

TBMS-MCR0800

T-BAT-SYS-HV-R2.5 Module

TP-HR25

T-BAT-SYS-HV-R3.6 Module

TP-HR36

Note: There are 2 models of T-BAT system, which includes BMS, and battery module(s). Refer to section 3.3 T-BAT-SYS-HV Configuration List on Page 13 for detailed models.

1.2 Target Group

This manual is for qualified electricians. The tasks described in this manual may only be performed by qualified electricians.

1.3 Symbols

The following types of safety instructions appear in this document and are described below:

	DANGER! “DANGER” indicates a hazardous situation which, if not avoided, will result in serious injury or death.
---	---

	WARNING! “WARNING” indicates a hazardous situation which, if not avoided, could result in serious injury or death.
---	--

	CAUTION! “CAUTION” indicates a hazardous situation which, if not avoided, could result in minor or moderate injury.
---	---

	NOTE! “NOTE” provides tips that are valuable for the optimal operation of your product.
---	---

2 Safety

2.1 Safety Instructions

For safety reasons, installers are responsible for familiarizing themselves with the contents of the Manual and all warnings before performing installation.

2.1.1 General Safety Precautions

	WARNING! Do not crush or impact the battery, and always dispose of it according to safety regulations.
---	--











Observe the following precautions:

- Risks of explosion:
 - Do not subject the battery module to heavy impacts;
 - Do not crush or puncture the battery module;
 - Do not dispose of the battery module in a fire.
- Risks of fire:
 - Do not expose the battery module to temperature exceeding 140°F (6°C);
 - Do not place the battery module near a heat source, such as a fireplace;
 - Do not expose the battery module to direct sunlight; and
 - Do not allow the battery connectors to touch conductive objects such as wires.
- Risks of electric shock:
 - Do not disassemble the battery module;
 - Do not touch the battery module with wet hands;
 - Do not expose the battery module to moisture or liquids; and
 - Keep the battery module away from children and animals.
- Risks of damage to the battery module:
 - Do not expose the battery module to liquids;
 - Do not subject the battery module to high pressures;
 - Do not place any objects on top of the battery module; and
 - It shall be protected from the sun and rain.

T-BAT SYS-HV should only be installed for residential applications but not for commercial applications.

	CAUTION! Non-operational batteries should be discarded according to local regulations.
---	--

2.1.2 Explanation of Symbols

Symbol	Explanation
	CE mark of conformity
	TUV certification
	The battery system must be disposed of at a proper facility for environmentally-safe recycling.
	UKCA mark of conformity
	Do not dispose of the battery together with household waste.
	Read the enclosed documentation.
	Keep the battery system away from open flames or ignition sources.
	Keep the battery system away from children.
	Caution, risk of electric shock
	Caution, risk of danger
	The battery module may explode.

2.2 Response to Emergency Situations

2.2.1 Leaking Batteries

In case the leakage of electrolyte solution occurs, please avoid direct contact with the electrolyte solution and the gas that may be generated by it. Direct contact may lead to skin irritation or chemical burns. If the user comes into contact with the electrolyte solution, please do as follows:

- Accidental inhalation of harmful substances:
Evacuate from the contaminated area, and seek medical attention immediately.
- Eye contact:
Rinse eyes with flowing water for 15 minutes, and seek medical attention immediately.
- Dermal contact:
Wash the affected area thoroughly with soap and water, and seek medical attention immediately.
- Ingestion:
Induce vomiting, and seek medical attention immediately.

2.2.2 Fire

Please keep a Class ABC fire extinguisher or a carbon dioxide extinguisher near the equipment.



	WARNING! The battery module may catch fire when heated above 302°F.
--	---

If a fire breaks out where the battery module is installed, please do as follows:

- 1) Extinguish the fire before the battery module catches fire;
- 2) If the battery module catches fire, please do not try to put out the fire, and evacuate immediately.

	WARNING! In case of catching fire, the battery module will produce noxious and poisonous gases. Please keep away!
--	---

2.2.3 Wet Batteries and Damaged Batteries

Do not touch the battery module after being wet from and soaked in the water. Do not use the battery module if it is damaged. Otherwise, the loss to life and property will be caused.

Please pack the battery in its original packaging, and return it to our company or the distributor.

	CAUTION! Damaged batteries may leak electrolyte or produce flammable gas. If a user suspects that the battery is damaged, please immediately contact our company for advice and information.
--	--

2.3 Qualified Installer

	WARNING! All operations of T-BAT-SYS-HV relating to electrical connection and installation must be carried out by qualified personnel.
--	--

A skilled worker is defined as a trained and qualified electrician or installer who has all of the following skills and experience:

- Knowledge of the functional principles and operation of grid-tied systems;
- Knowledge of the dangers and risks associated with installing and using electrical devices and acceptable mitigation methods;
- Knowledge of the installation of electrical devices; and
- Knowledge of and adherence to this manual and all safety precautions and best practices.

3 Product Introduction

3.1 Product Overview

For safety reasons, installers are responsible for familiarizing themselves with the contents of the Manual and all warnings before performing installation.

3.1.1 Dimensions and Weight

A battery management system (BMS) is an electronic system that manages a rechargeable battery.

A battery module is a type of electrical battery which can be charged or discharged into a load.

A battery system includes BMS, battery module(s) and a Rack (or Cabinet).

	Rack		
	Front Support	Rear Support	Metal Plate
Length	18.94 in./481.00 mm	17.65 in./448.40 mm	15.26 in./387.50 mm
Width	1.26 in./32.00 mm	1.26 in./32.00 mm	1.34 in./34.00 mm
Height	6.04 in./153.50 mm	6.04 in./153.50 mm	0.31 in./8.00 mm
Weight	3.97 lbs/1.8 kg		

Rack

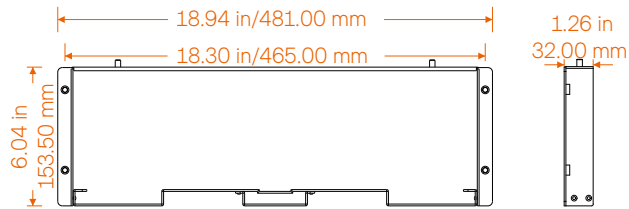

Front

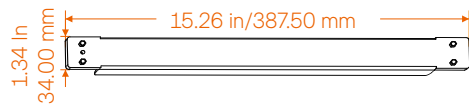

Metal Plate

Cabinet

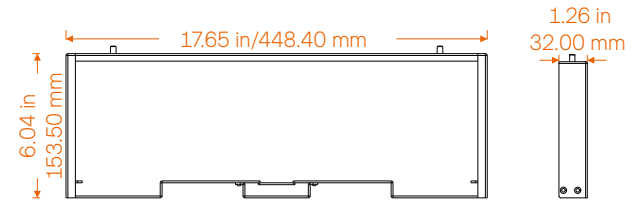

Rear

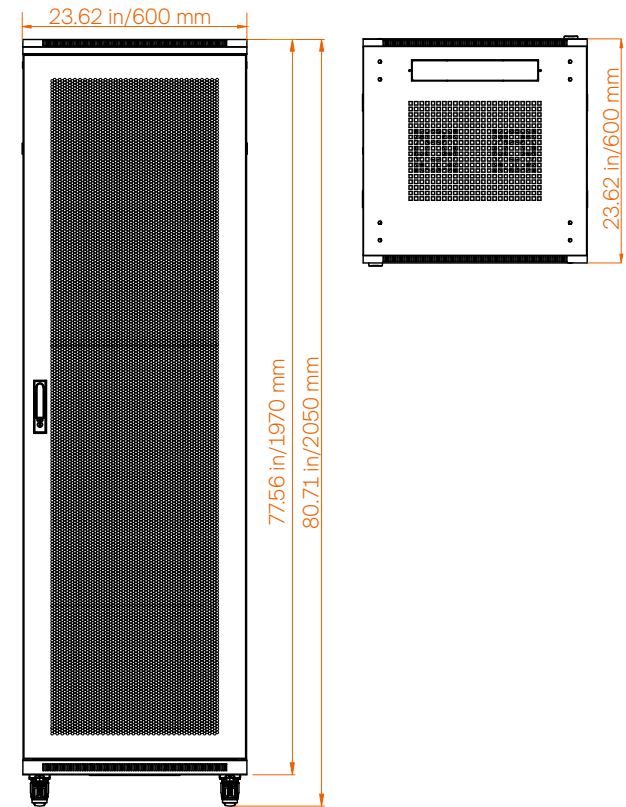

	TBMS-MCR0800	TP-HR25	TP-HR36
Length	17.40 in./442.00 mm	17.40 in./442.00 mm	17.40 in./442.00 mm
Width	15.39 in./391.00 mm	15.39 in./391.00 mm	15.39 in./391.00 mm
Height	5.12 in./130.00 mm	5.12 in./130.00 mm	5.12 in./130.00 mm
Weigth	17.64 lbs/8.00 kg	61.73 lbs/28.00 kg	68.34 lbs/31.00 kg

BMS (TBMS-MCR0800)

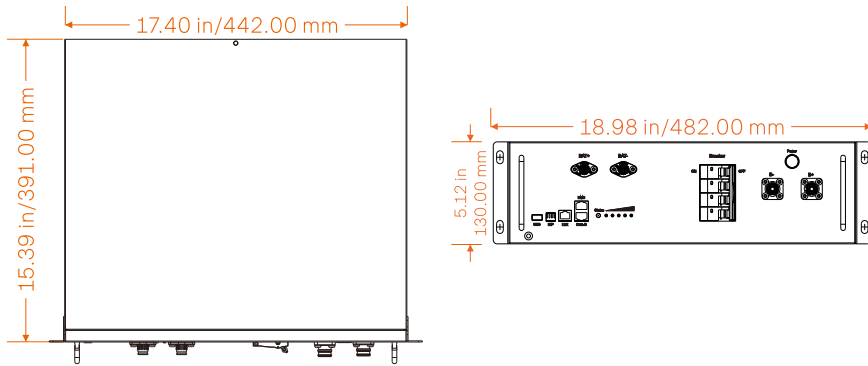

Battery Module (TP-HR25/TP-HR36)

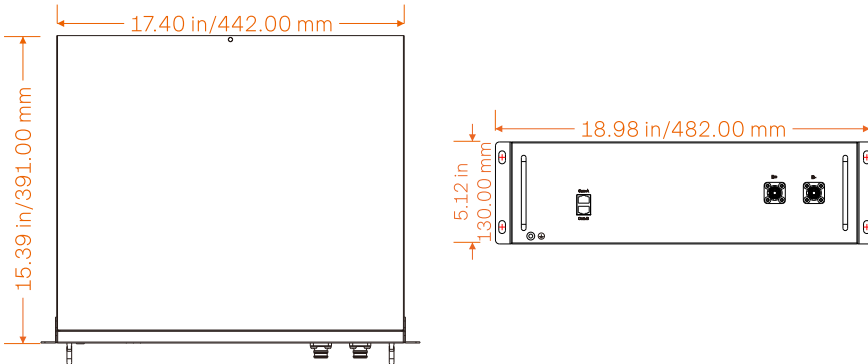

3.1.2 Installation Space

■ Rack Installation

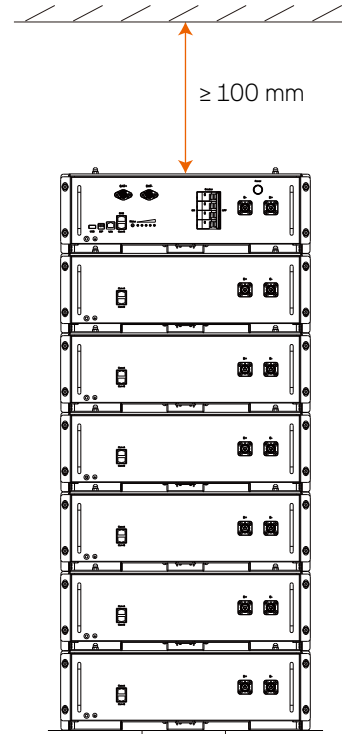

■ Cabinet Installation

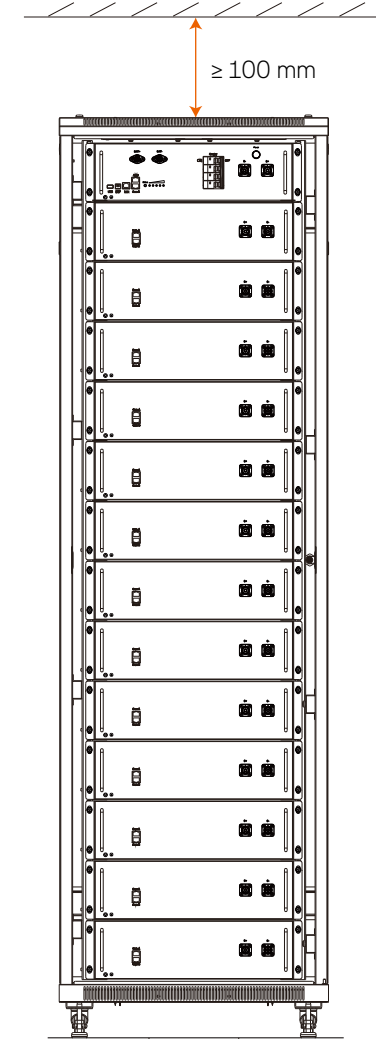

Note!

- 1 Currently, a Rack may withstand up to a BMS and 6 battery modules.
- 2 The above Cabinet is a standard cabinet, with both height and depth of 23.62 inches/600 mm. Users can purchase it based on their demands.

3.1.3 Appearance

■ Section view of TBMS-MCR0800

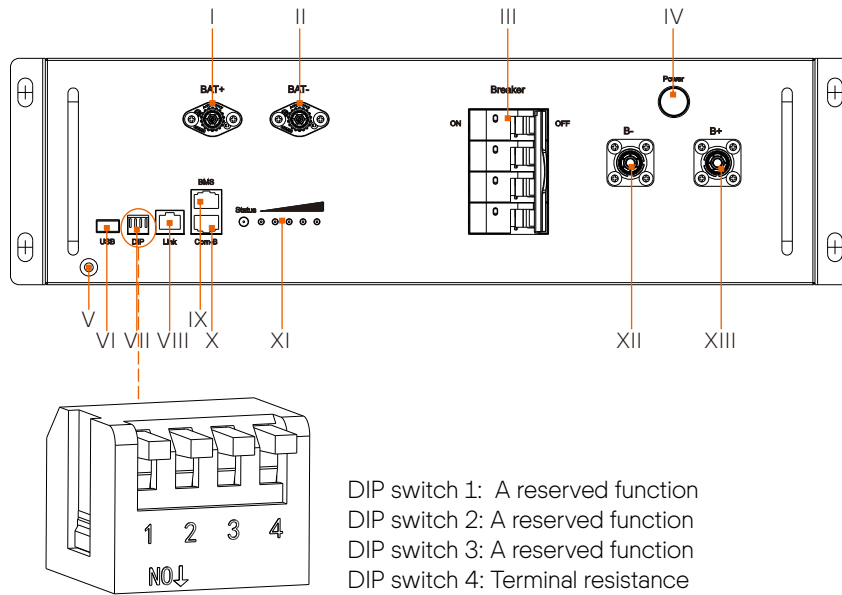

DIP switch 1: A reserved function
 DIP switch 2: A reserved function
 DIP switch 3: A reserved function
 DIP switch 4: Terminal resistance

No.	Description
I	BAT+: Connect BMS's BAT+ to inverter's BAT+
II	BAT-: Connect BMS's BAT - to inverter's BAT-
III	Breaker: Input and output switch of battery module
IV	Power Button: Open/close the battery system
V	GND: BMS's GND
VI	USB Port: A expansion function
VII	DIP: Parallel operation of battery modules
VIII	Link Port: Communication port for parallel operation of battery modules
IX	BMS Port: Connect BMS's communication port and inverter's communication port
X	COM-B: Connect battery module's COM A
XI	Lamp Panel: Display real-time battery status
XII	B-: Connect BMS's B- to battery module's B+
XIII	B+: Connect BMS's B+ to battery module's B-

■ Section view of TP-HR25/TP-HR36

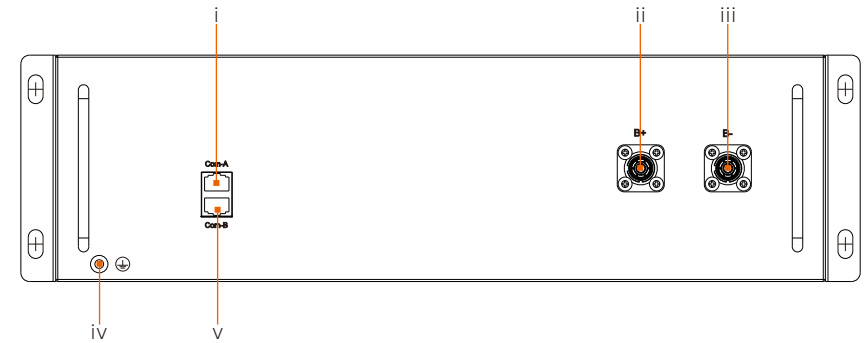

No.	Description
i	COM-A: Connect BMS's COM B or battery module's COM B
ii	B+: Connect BMS's B- or battery module's B-
iii	B-: Connect BMS's B+ or battery module's B+
iv	GND: Battery module's GND
v	COM-B: Connect battery module's COM A

3.2 Basic Features

3.2.1 Features

The T-BAT-SYS-HV is one of the most advanced energy storage systems on the market today, using state-of-the-art technology, and having the characteristics of high reliability and convenient control. Characteristics are shown as follows:

- 90% DOD;
- 95% Battery Roundtrip Efficiency;
- Cycle Life > 6000 Cycles;
- Secondary Protection;
- IP20 Protection Level and Protection Class I;
- Safety & Reliability;
- Small Occupied Area;
- Floor Mounting.

3.2.2 Certifications

BAT system safety	CE, RCM, IEC 62619, IEC 62620, IEC 62477-1, IEC 60730 Annex H, IEC 62040, VDE-AR-E2510, IEC 60529, UN38.3
UN number	UN 3480
Hazardous materials classification	Class 9
UN transportation testing requirements	UN 38.3
International protection marking	IP20, Protection Class I

3.3 Specifications

3.3.1 T-BAT-SYS-HV-R2.5

■ Configuration List

No.	Module	BMS	Battery Module	Nominal Energy (kWh)	Operating Voltage (Vdc)
1	T-BAT H R5.0	TBMS-MCR0800 × 1	TP-HR25 × 2	5.12	90-116
2	T-BAT H R7.5	TBMS-MCR0800 × 1	TP-HR25 × 3	7.68	135-174
3	T-BAT H R10.0	TBMS-MCR0800 × 1	TP-HR25 × 4	10.24	180-232
4	T-BAT H R12.5	TBMS-MCR0800 × 1	TP-HR25 × 5	12.8	225-290
5	T-BAT H R15.0	TBMS-MCR0800 × 1	TP-HR25 × 6	15.36	270-349
6	T-BAT H R17.5	TBMS-MCR0800 × 1	TP-HR25 × 7	17.92	315-406
7	T-BAT H R20.0	TBMS-MCR0800 × 1	TP-HR25 × 8	20.48	360-465
8	T-BAT H R22.5	TBMS-MCR0800 × 1	TP-HR25 × 9	23.04	405-522
9	T-BAT H R25.0	TBMS-MCR0800 × 1	TP-HR25 × 10	25.6	450-580
10	T-BAT H R27.5	TBMS-MCR0800 × 1	TP-HR25 × 11	28.16	495-636
11	T-BAT H R30.0	TBMS-MCR0800 × 1	TP-HR25 × 12	30.72	540-695
12	T-BAT H R32.5	TBMS-MCR0800 × 1	TP-HR25 × 13	33.28	585-750

■ Performance

Module	T-BAT H R5.0	T-BAT H R7.5	T-BAT H R10.0	T-BAT H R12.5	T-BAT H R15	T-BAT H R17.5
Nominal Voltage (Vdc)	102.4	153.6	204.8	256	307.2	358.4
Operating Voltage (Vdc)	90-116	135-174	180-232	225-290	270-349	315-406
Nominal Capacity (Ah) ①	50	50	50	50	50	50
Nominal Energy (kWh) ①	5.12	7.68	10.24	12.8	15.36	17.92
Usable Energy 90% DOD (kWh) ②	4.6	6.9	9.2	11.5	13.8	16.1
Max. Charge/Discharge Current (A) ③	45	45	45	45	45	45
Recommend Charge/Discharge Current (A) ⑤	30	30	30	30	30	30
Standard Power (kW)	2.56	3.84	5.12	6.4	7.68	8.96
Max. Power (kW)	4.6	6.9	9.2	11.5	13.8	16.1
Short-circuit Current (A)	2500	2500	2500	2500	2500	2500
Battery Roundtrip Efficiency (0.2C, 25°C/77°F)	95%					
Expected Lifetime (25°C/77°F)	10 Years					
Cycle Life 90% DOD (25°C/77°F)	6000 Cycles					
Charge Temperature	32°F-122°F/0°C-50°C ④					
Discharge Temperature	-4°F-122°F/-20°C-50°C ④					
Storage Temperature	-4°F-86°F/-20°C-30°C (12 months) 86°F-122°F/30°C-50°C (6 months)					
Ingress Protection	IP20					
Preotection Class	I					

Continued on the next page

Module	T-BAT H R20	T-BAT H R22.5	T-BAT H R25	T-BAT H R27.5	T-BAT H R30	T-BAT H R32.5
Nominal Voltage (Vdc)	409.6	460.8	512	563.2	614.4	665.6
Operating Voltage (Vdc)	360-465	405-522	450-580	495-636	540-695	585-750
Nominal Capacity (Ah) ①	50	50	50	50	50	50
Nominal Energy (kWh) ①	20.48	23.04	25.6	28.16	30.72	33.28
Usable Energy 90% DOD (kWh) ②	18.4	20.7	23.0	25.3	27.6	30
Max. Charge/Discharge Current (A) ③	45	45	45	45	45	45
Recommend Charge/Discharge Current (A) ⑤	30	30	30	30	30	30
Standard Power (kW)	10.24	11.52	12.8	14.08	15.36	16.64
Max. Power (kW)	18.4	20.7	23	25.3	27.6	30
Short-circuit Current (A)	2500	2500	2500	2500	2500	2500
Battery Roundtrip Efficiency (0.2C, 25°C/77°F)	95%					
Expected Lifetime (25°C/77°F)	10 Years					
Cycle Life 90% DOD (25°C/77°F)	6000 Cycles					
Charge Temperature	32°F~122°F/0°C~50°C ④					
Discharge Temperature	-4°F~122°F/-20°C~50°C ④					
Storage Temperature	-4°F~86°F/-20°C~30°C (12 months) 86°F~122°F/30°C~50°C (6 months)					
Ingress Protection	IP20					
Protection Class	I					

Note:

- ① Test conditions: 100% DOD, 0.2C charge & discharge @+ 77°F/25°C.
 ② 90% DOD; System usable energy may vary with inverter different setting.
 ③ Discharge: In case of the battery cell's temperature range of -4°F~14°F/-20°C~10°C and 113°F~122°F/45°C ~50°C, the discharge current will be reduced; Charge: In case of the battery cell's temperature range of 32°F~77°F/0°C~25°C and 113°F~122°F/45°C ~50°C, the charge current will be reduced. Product charge or discharge power depends on the actual temperature of the battery pack.
 ④ The battery can only be discharged and cannot be charged at -4°F~32°F/-20°C~0°C.
 ⑤ In case of a rated current of 30 A, the wire size of 10 AWG for ground wire is recommended; in case of a rated current of 45 A, the wire size of 8 AWG for ground wire is recommended. Note: The above-mentioned ground wires shall be prepared by the user self.
 ⑥ In the allowable range, the relative humidity range should be between 0% and 90% RH.

3.3.2 T-BAT-SYS-HV-R3.6

■ Configuration List

No.	Module	BMS	Battery Module	Nominal Energy (kWh)	Operating Voltage (Vdc)
1	T-BAT H R7.2	TBMS-MCR0800 × 1	TP-HR36 × 2	7.37	90-116
2	T-BAT H R10.8	TBMS-MCR0800 × 1	TP-HR36 × 3	11.06	135-174
3	T-BAT H R14.4	TBMS-MCR0800 × 1	TP-HR36 × 4	14.75	180-232
4	T-BAT H R18.0	TBMS-MCR0800 × 1	TP-HR36 × 5	18.43	225-290
5	T-BAT H R21.6	TBMS-MCR0800 × 1	TP-HR36 × 6	22.12	270-349
6	T-BAT H R25.2	TBMS-MCR0800 × 1	TP-HR36 × 7	25.8	315-406
7	T-BAT H R28.8	TBMS-MCR0800 × 1	TP-HR36 × 8	29.49	360-465
8	T-BAT H R32.4	TBMS-MCR0800 × 1	TP-HR36 × 9	33.18	405-522
9	T-BAT H R36	TBMS-MCR0800 × 1	TP-HR36 × 10	36.86	450-580
10	T-BAT H R39.6	TBMS-MCR0800 × 1	TP-HR36 × 11	40.55	495-636
11	T-BAT H R43.2	TBMS-MCR0800 × 1	TP-HR36 × 12	44.24	540-695
12	T-BAT H R46.8	TBMS-MCR0800 × 1	TP-HR36 × 13	47.92	585-750

■ Performance

Module	T-BAT H R7.2	T-BAT H R10.8	T-BAT H R14.4	T-BAT H R18.0	T-BAT H R21.6	T-BAT H R25.2
Nominal Voltage (Vdc)	102.4	153.6	204.8	256	307.2	358.4
Operating Voltage (Vdc)	90-116	135-174	180-232	225-290	270-349	315-406
Nominal Capacity (Ah) ①	72	72	72	72	72	72
Nominal Energy (kWh) ①	7.37	11.06	14.75	18.43	22.12	25.80
Usable Energy 90% DOD (kWh) ②	6.6	10.0	13.3	16.6	19.9	23.2
Max. Charge/Discharge Current (A) ③	50	50	50	50	50	50
Recommend Charge/Discharge Current (A) ⑤	35	35	35	35	35	35
Standard Power (kW)	3.58	5.38	7.17	8.96	10.75	12.54
Max. Power (kW)	5.12	7.68	10.24	12.8	15.36	17.92
Short-circuit Current (A)	2500	2500	2500	2500	2500	2500
Battery Roundtrip Efficiency (0.2C, 25°C/77°F)	95%					
Expected Lifetime (25°C/77°F)	10 Years					
Cycle Life 90% DOD (25°C/77°F)	6000 Cycles					
Charge Temperature	32°F~122°F/0°C~50°C ④					
Discharge Temperature	-4°F~122°F/-20°C~50°C ④					
Storage Temperature	-4°F~86°F/-20°C~30°C (12 months) 86°F~122°F/30°C~50°C (6 months)					
Ingress Protection	IP20					
Protection Class	I					

Continued on the next page

Module	T-BAT H R28.8	T-BAT H R32.4	T-BAT H R36	T-BAT H R39.6	T-BAT H R43.2	T-BAT H R46.8
Nominal Voltage (Vdc)	409.6	460.8	512	563.2	614.4	665.6
Operating Voltage (Vdc)	360-465	405-522	450-580	495-636	540-695	585-750
Nominal Capacity (Ah) ①	72	72	72	72	72	72
Nominal Energy (kWh) ①	29.49	33.18	36.86	40.55	44.24	47.92
Usable Energy 90% DOD (kWh) ②	26.5	29.9	33.2	36.5	39.8	43.1
Max. Charge/Discharge Current (A) ③	50	50	50	50	50	50
Recommend Charge/Discharge Current (A) ⑤	35	35	35	35	35	35
Standard Power (kW)	14.34	16.13	17.92	19.71	21.50	23.3
Max. Power (kW)	20.48	23.04	25.6	28.16	30.72	33.28
Short-circuit Current (A)	2500	2500	2500	2500	2500	2500
Battery Roundtrip Efficiency (0.2C, 25°C/77°F)	95%					
Expected Lifetime (25°C/77°F)	10 Years					
Cycle Life 90% DOD (25°C/77°F)	6000 Cycles					
Charge Temperature	32°F~122°F/0°C~50°C ④					
Discharge Temperature	-4°F~122°F/-20°C~50°C ④					
Storage Temperature	-4°F~86°F/-20°C~30°C (12 months) 86°F~122°F/30°C~50°C (6 months)					
Ingress Protection	IP20					
Protection Class	I					

Note:

- ① Test conditions: 100% DOD, 0.2C charge & discharge @+ 77°F/25°C.
 ② 90% DOD; System usable energy may vary with inverter different setting.
 ③ Discharge: In case of the battery cell's temperature range of -4°F~14°F/-20°C~10°C and 113°F~122°F/45°C ~50°C, the discharge current will be reduced; Charge: In case of the battery cell's temperature range of 32°F~77°F/0°C~25°C and 113°F~122°F/45°C ~50°C, the charge current will be reduced. Product charge or discharge power depends on the actual temperature of the battery pack.
 ④ The battery can only be discharged and cannot be charged at -4°F~32°F/-20°C~0°C.
 ⑤ In case of a rated current of 30 A, the wire size of 10 AWG for ground wire is recommended; in case of a rated current of 50 A, the wire size of 8 AWG for ground wire is recommended. Note: The above-mentioned ground wires shall be prepared by the user self.
 ⑥ In the allowable range, the relative humidity range should be between 0% and 90% RH.

4 Preparation before Installation

4.1 Prerequisites

When assembling the system, avoid touching the battery terminals with any metal object or bare hands. According to the design principles, T-BAT-SYS-HV will provide a safe and reliable energy. Improper operation and equipment damage may cause overheating and electrolyte leakage. Therefore, the above-mentioned safety precautions and warning information mentioned in this part shall be strictly observed. If you have any question, please contact customer service. The “2 Safety” does not contain the provisions of all laws and regulations at the place where the user located.

Before installation, make sure that the installation site meets the following conditions:

- The building can stand up to earthquakes;
- The site shall be over 0.62 miles/997.79 m away from the sea, to avoid damage caused by salt water and humidity;
- The floor shall be flat;
- No inflammable and explosive goods are placed within at least of 3 ft/0.91 m;
- The ambience shall be shady and cool, away from heat sources and direct sunlight;
- The temperature and humidity remain at a constant level;
- The installation site requires less dust and dirt; and
- There are no corrosive gases, including ammonia and acid vapor.



NOTE!

If the ambient temperature exceeds the operating range, the battery pack will stop running to protect itself. The optimal temperature range for running is 59°F/15°C to 86°F/30°C. In the allowable range, the relative humidity range should be between 0% and 90% RH. Frequent exposure to harsh temperatures may deteriorate the performance and lifetime of the battery.

4.2 Safety Gear

Installation and maintenance personnel must operate according to applicable federal, state, and local regulations as well as industry standards regarding product installation. Personnel must wear safety gear as indicated below in order to avoid short circuit and personal injury.



Safety Gloves



Safety Shoes

4.3 Tools

These tools are required to install the T-BAT system.

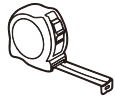

Measuring tape

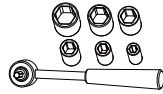

Torque wrench (M6)



Marker



Wire stripper

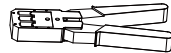

Crimping tool for Rj45



Cross screwdriver

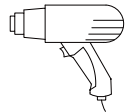

Heat gun

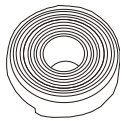

Ø8 mm Heat shrink tubing



Metal pry

4.4 Preparation

4.4.1 Check for Transport Damage

Ensure the battery is intact during and after transportation. If there are visible damages such as cracks, contact your dealer immediately.

4.4.2 Unpacking

Unpack the battery package by removing the packing tape. Ensure the battery modules and relevant items are complete. Refer to the packaging items in section "4.4.3 Accessories" and check the packing lists carefully. If any accessory is missing, immediately contact our company or your distributor directly.



CAUTION!

According to regional regulations, several people may be required for moving the equipment.



WARNING!

Strictly follow the installation steps. Our company will not be responsible for any injuries or loss incurred by incorrect assembly and operation.



NOTE!

When installing the battery for the first time, the manufacturing date between battery modules should not exceed 3 months.

4.4.3 Accessories

■ BMS (TBMS-MCR0800):



Accessories included are shown as follows:

Item	Description	Quantity
A	Communication Cable	1
B	Power Cable (Black)	1
C	Power Cable (Red)	1
D	Cross External Hexagon Screw (M6*L16)	4
E	Ground Terminal	2
F	Cable Tie (to ground cables together)	3
G	Document	2
H*	Power Cable (1.2 m for 2 to 6 battery modules)	
I*	Power Cable (2.2 m for 7 to 13 battery modules)	

Note!

The accessory with the “*” mark indicates that it will not be provided by our company, and users can purchase from our company based on their own needs.

■ One Battery Module (TP-HR25/TP-HR36 × 1):

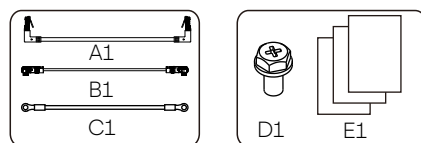

Accessories included are shown as follows:

Item	Description	Quantity
A1	Communication Cable	1
B1	Power Cable	1
C1	Ground Wire	1
D1	Cross External Hexagon Screw (M6*L16)	4
E1	Document	1

The above components are only for one battery module. Our company will provide corresponding components according to battery modules.

■ Accessories for Quick Rack

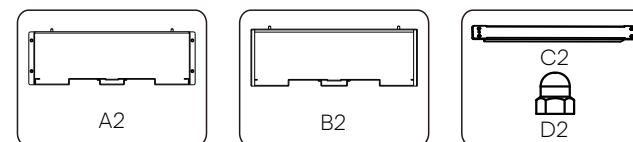

Accessories included are shown as follows:

Item	Description	Quantity
A2	Front Support	1
B2	Rear Support	1
C2	Metal IPlate	1
D2	Cap Nut	4

■ Accessories for Cabinet

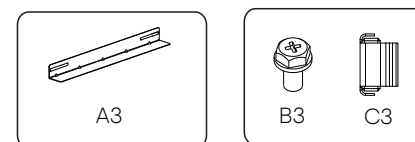

Accessories included are shown as follows:

Item	Description	Quantity
A3	L-shaped Transverse Support	2
B3	Cross External Hexagon Screw (M6*L16)	4
C3	Cassette Nut (M6)	8

5. Equipment Installation

5.1 Installation Environment Requirements

- Ensure that the equipment is installed in a well ventilated environment;
- To prevent fire due to high temperature, ensure that the ventilation vents or heat dissipation system are not blocked when the equipment is running;
- Do not expose the equipment to flammable or explosive gas or smoke. Do not perform any operation on the equipment in such environments;
- Ensure that the area is completely waterproof, and the floor is flat and level; and
- Ensure that the temperature and humidity is maintained at a constant level, and there is minimal dust and dirt in the area.

5.2 Installation Mode

There are two alternative installation modes (rack and cabinet) available for users.

5.2.1 Rack Installation

Regarding the Rack, users can purchase from our company. The following steps take 6 battery modules as an example.

■ Installation Step

Step 1. Assemble rack

- ① Determine the front and rear supports, and place them on the floor.
- ② Place the metal plate connecting both front and rear supports.

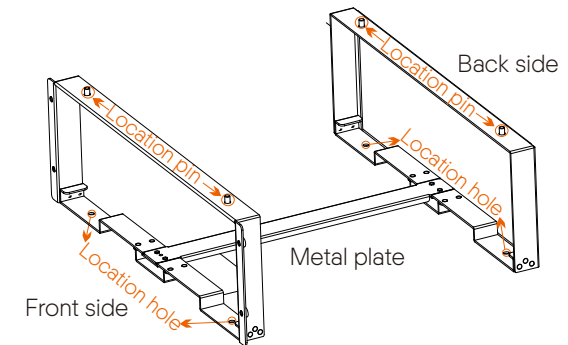
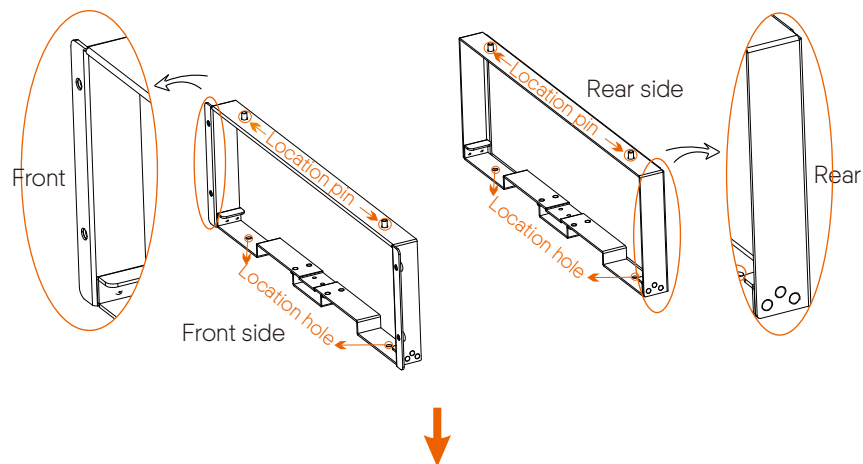

Step 2.

- ① Put the battery module into the rack.
- ② Take the M6 x L16 screws (4 pcs) provided, and correctly insert and tighten M6xL16 into the front support of the rack (Torque: 4-5 N·m).

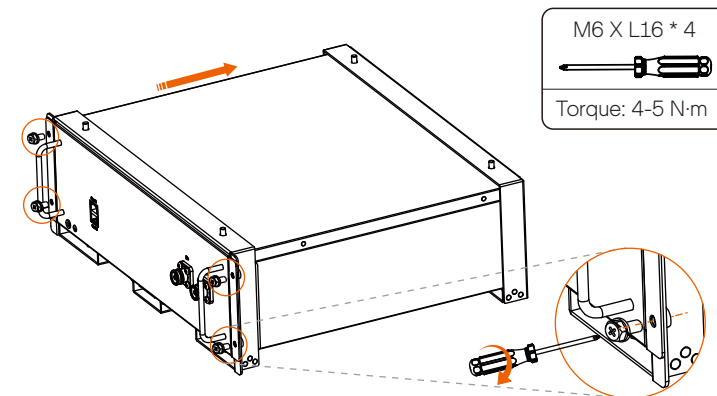

Step 3. Add the rack and battery module

- ① Place the Front and Rear Supports, to make sure that location pins are securely inserted into the location holes.
- ② Screw both front and rear supports with Cap Nuts (4 pcs) (Torque: 4-6 N·m).
- ③ Place the metal plate connecting both front and rear supports.
- ④ Gently place the battery module into the rack, and correctly insert and tighten M6×L16 into the front side of the second rack (Torque: 4-5 N·m).

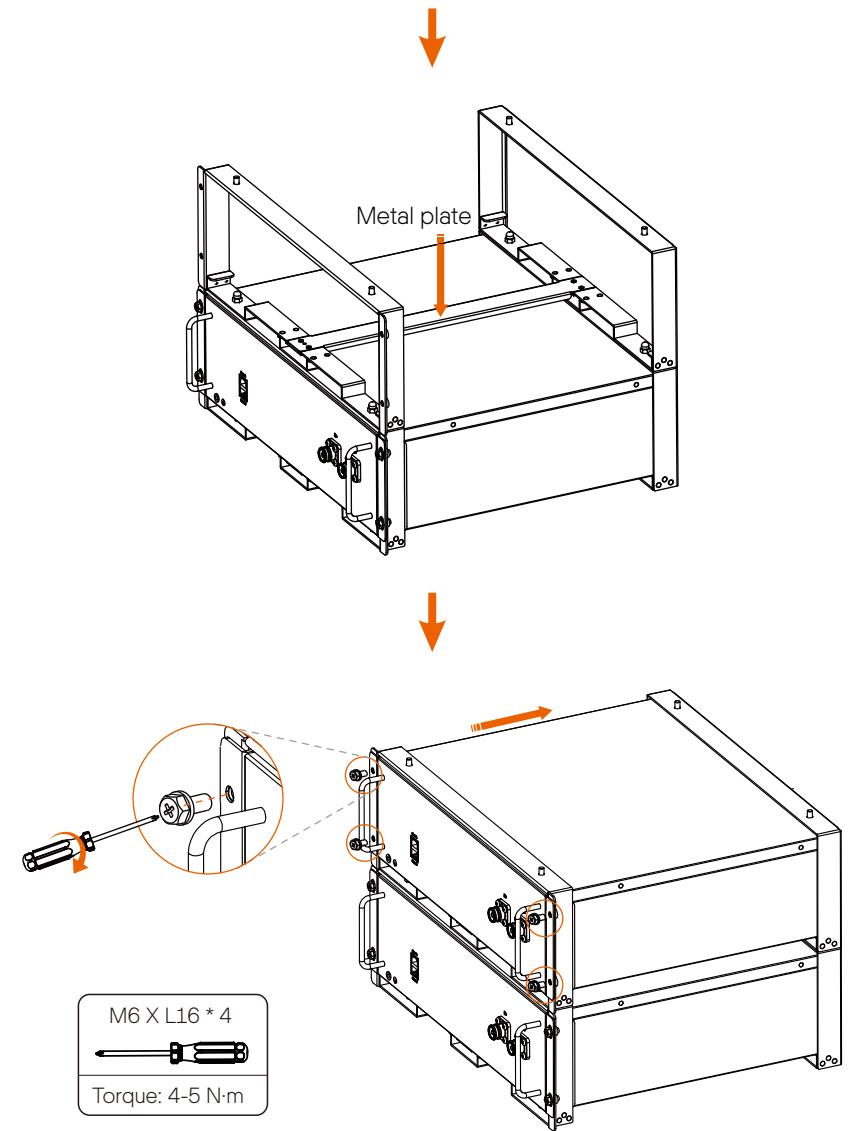
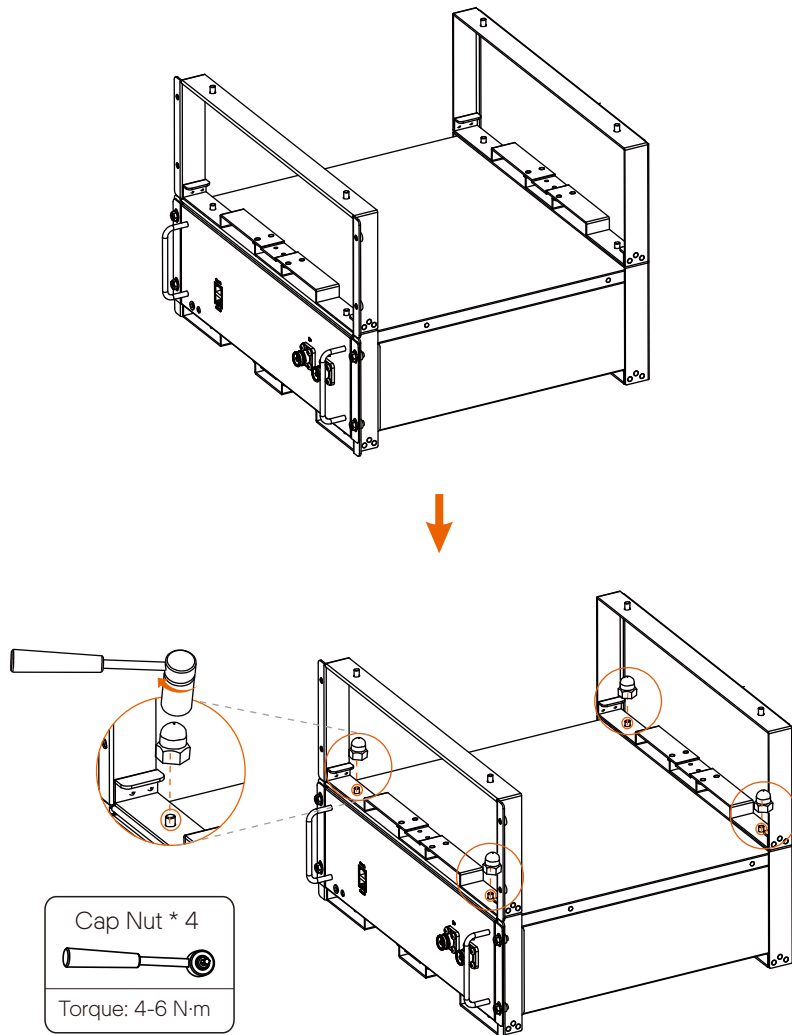

Step 4. Repeat step 3 to install the remaining battery modules and the BMS.
After installation is completed, it is shown as follows:

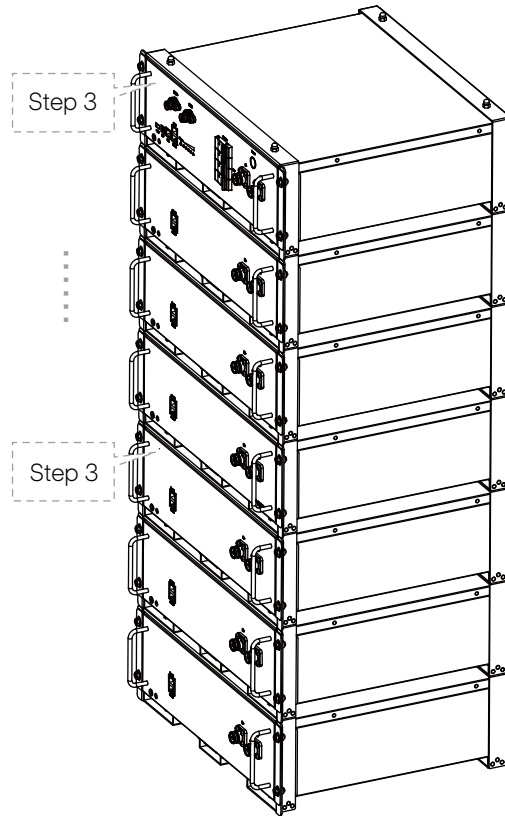

⚠ Caution!

There are three disassembly methods, with details as follows:

- 1 If the entire device needs to be replaced, strictly follow the reverse order of the installation procedure to remove the rack, the BMS, and battery modules from top to down.
- 2 If one of the battery modules needs to be maintained, just remove such a battery module, and then reinstall it back in place after finishing maintenance.
- 3 If more than one battery module needs to be maintained, please do as follows:
Firstly, remove one battery module to do maintenance;
Secondly, reinstall the battery module back in place after finishing maintenance;
Thirdly, repeat the above two steps to maintain another battery module.

■ Wiring

After installation, connect a battery module to another battery (or BMS), and BMS to inverter.

- Battery module to battery module (or BMS)

Communication cable (1 pcs), power cable (1 pcs) and ground wire (1 pcs) are provided in our packing list.

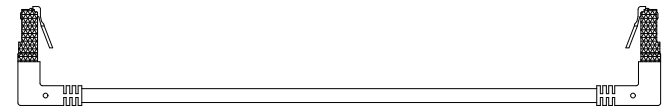

Communication cable: there are two registered jacks at both ends; one connects to Com-A of a battery module, and the other connects to Com-B of the neighboring battery module (or COMM of BMS).

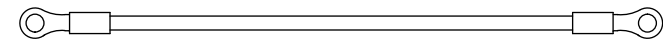

Ground wire: there are two terminals at both ends; one connects to a grounding point of a battery module; and the other connects to grounding point of the neighboring battery module or BMS.

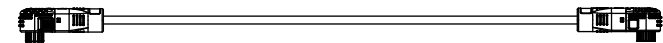

Power cable: there are two terminals with the same function at both ends; a power cable in the packing list of battery module, one end connects to B+ of a battery module, and the other connects to B- of the neighboring battery module (or B- of BMS). A power cable in the packing list of BMS, one end connects B+ of BMS and the other connects B- of a battery module at the bottom of the rack.

⚠ Caution!

Press and hold the “Lock Button” while unplugging the power cable. Otherwise, it cannot be pulled out.

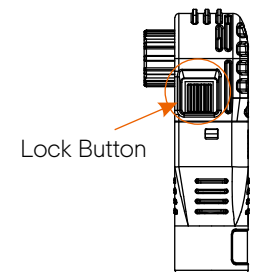

Connect cables between battery modules, and battery to BMS. See figure below.

- Battery module to neighboring battery module:
Power cable: "B+" port to "B-" port;
Communication cable: "Com-A" port to "Com-B" port;
Grounding cable: Grounding port to grounding port.
- Battery module to the BMS:
Power cable: "B-" port of the battery to "B+" of the BMS;
Communication: "Com-A" port of the battery to "Com-B" port of the BMS;
Grounding cable: Grounding port of the battery to grounding port of the BMS.

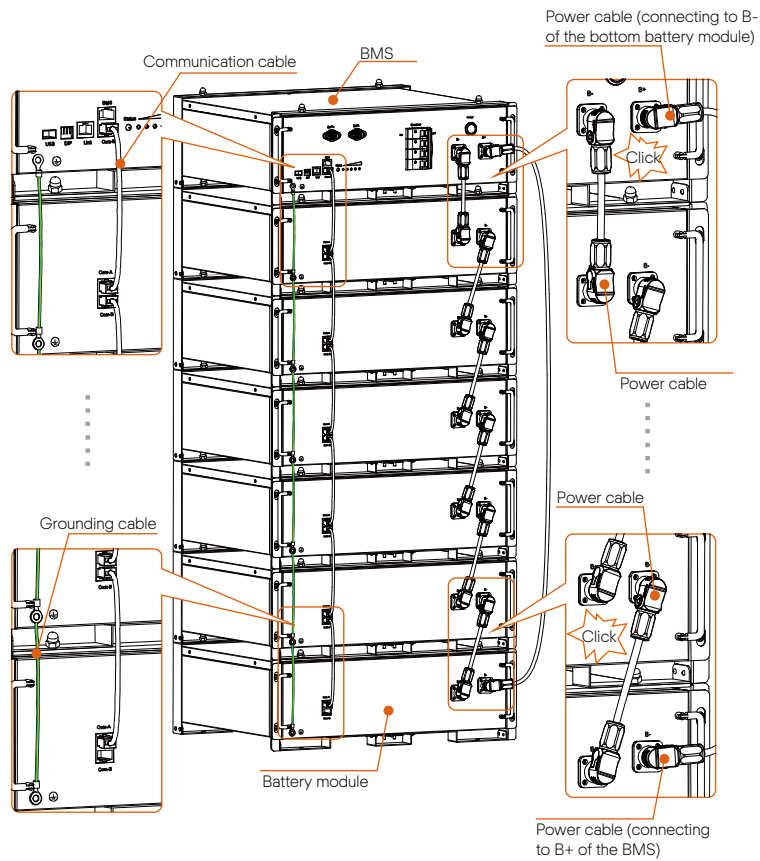

Note!

- Press and hold the "Lock button" while unplugging the power cable. Otherwise, it cannot be pulled out.
- Don't violently remove the power cables when they are locked.

- BMS to Inverter

Note!

The connector connecting to inverter from BMS is delivered with the inverter, for details, please refer to the inverter's User Manual.



Power cable (black): Connect BAT- of BMS to BAT- of inverter



Power cable (red): Connect BAT+ of BMS to BAT+ of inverter

Caution!

Press and hold the "Lock Button" while unplugging the power cable. Otherwise, it cannot be pulled out.

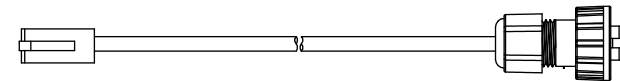
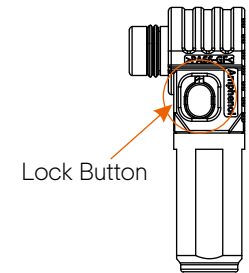

Communication cable: Connecting BMS's BMS and the inverter's BMS

■ Making a BMS communication cable

If users want to make a BMS communication cable or a BMS communication cable is required to be made before wiring, to ensure normal operation of BMS and inverter, please read the following carefully.

The specific definition of the communication cable is shown as follows:

Sequence	1	2	3	4	5	6	7	8
BMS	/	GND	/	BMS_H	BMS_L	/	A1	B1

The wire order of the communication cable is as follows:

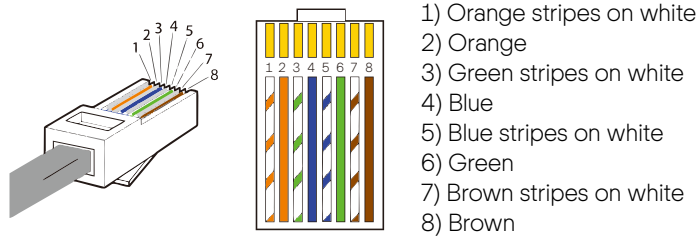

Note!

The BMS communication cable shall have a shield layer.

Connect cables between BMS and inverter. See figure below.

- BMS to inverter:
Power cable: "BAT+" port to "BAT+" port;
Communication cable: "BMS" port to "BMS" port;
Grounding cable: Grounding port to grounding port.

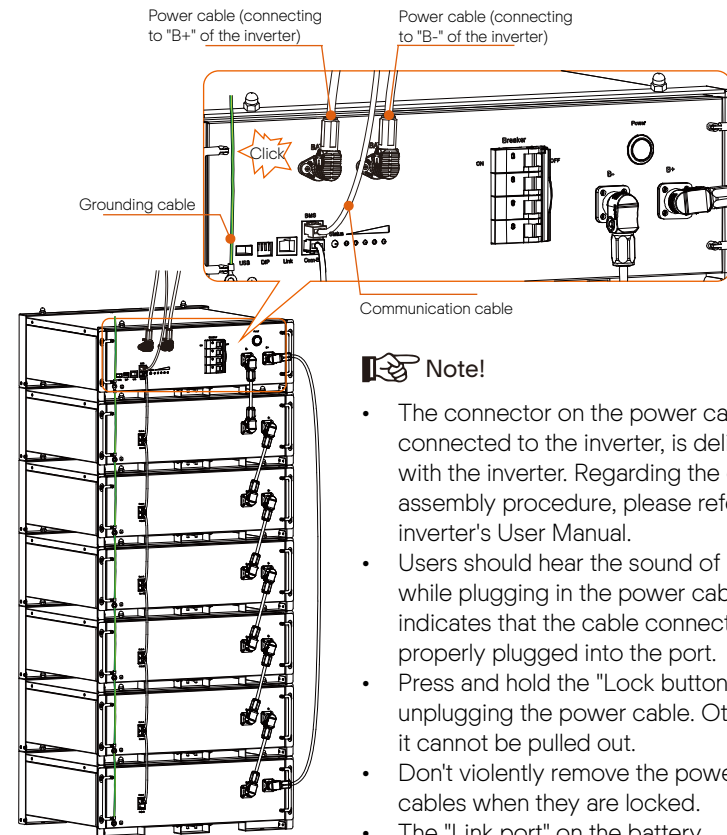

Note!

- The connector on the power cable, connected to the inverter, is delivered with the inverter. Regarding the detailed assembly procedure, please refer to the inverter's User Manual.
- Users should hear the sound of "Click" while plugging in the power cable. It indicates that the cable connector is properly plugged into the port.
- Press and hold the "Lock button" while unplugging the power cable. Otherwise, it cannot be pulled out.
- Don't violently remove the power cables when they are locked.
- The "Link port" on the battery management system (BMS) is for parallel connections only. Don't use it for any other purposes.

5.2.2 Cabinet Installation

As for the installation of outside cabinet, please follow the guide delivered with the cabinet.

 **Note!**

The following steps are taking 42U as an example.
 Where is the threading slot on the top of the cabinet? That is the front side.
 When installing outside cabinet, Cassette Nuts shall be inserted before installing Fixed Rails, with 4 Cassette Nuts for one Fixed Rails. There are totaling 3 Fixed Rails. 4 Cassette Nuts shall be inserted into each fixed rail. See figure below.

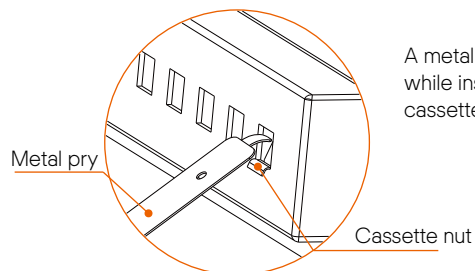
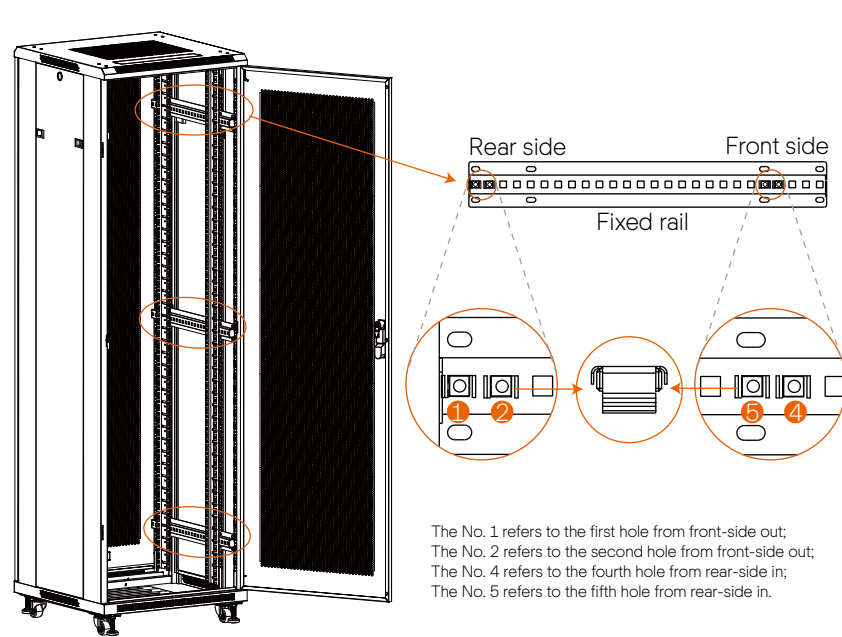

As for the installation of inside cabinet and battery modules, please follow the steps as below.

There are two alternative sizes (22U and 42U) of cabinets available for users. The following steps take 42U (1U = 4.445 cm) with 13 battery modules as an example.

■ Installation Step

Step 1. There are totaling 4 Mounting Rails. Insert Cassette Nuts into the holes on the Mounting Rails every 3U (1U = 4.445 cm), with totaling 14 Cassette Nuts of one Mounting Rail. See figure below.

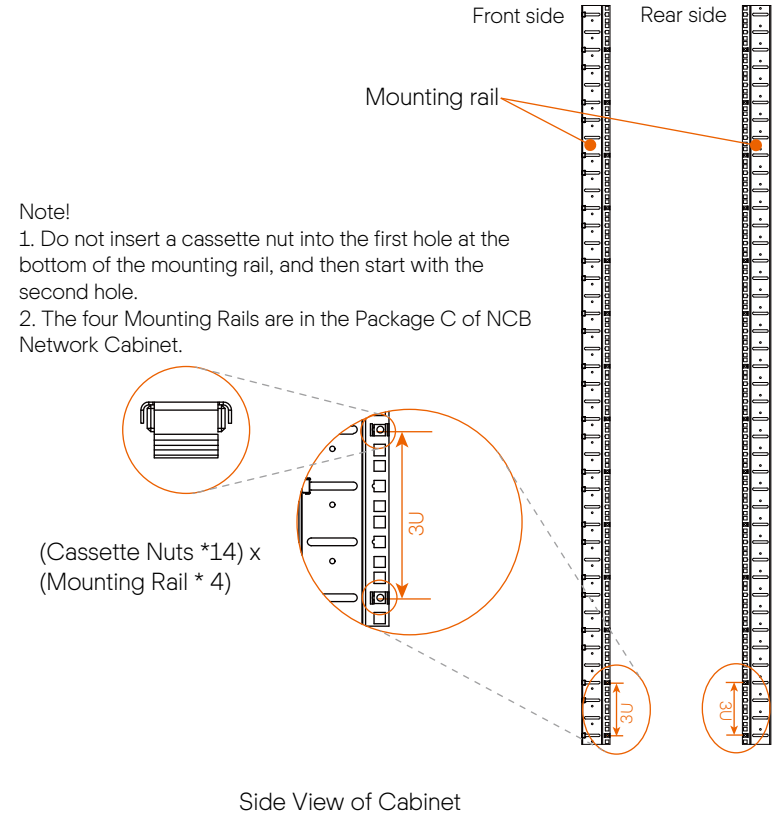

Step 2. Insert Cassette Nuts into holes on the front Mounting Rail facing the cabinet door, with a total of 28 Cassette Nuts per front Mounting Rail.

- ① Insert the first Cassette Nut into a hole;
- ② Insert the second Cassette Nut 2U from the first one;
- ③ Insert the third Cassette Nut 1U from the second one;
- ④ Insert the fourth Cassette Nut 2U from the third one;
- ⑤ Insert the fifth Cassette Nut 1U from the fourth one;
- ⑥ Then repeat ② and ③ to insert the following Cassette Nuts.

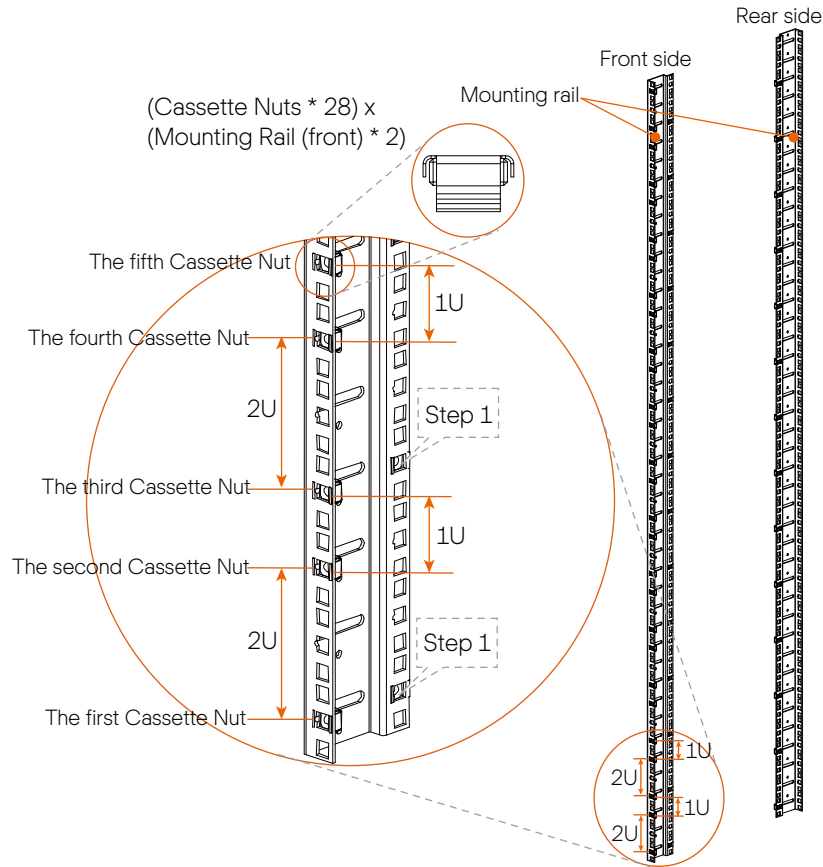

Side View of Cabinet

Note!

1. Do not insert a cassette nut into the first hole at the bottom of the mounting rail, and then start with the second hole.
2. 1U = 4.445 cm.

Step 3. Fix and screw the L-shaped Transverse Support on the Mounting Rails with Cross External Hexagon Screw (M6*L16 X 4) (Torque: 4-5 N·m). Make sure the two Mounting Rails on one side are at the same level.

The distance between two Mounting Rails on one side shall be no more than 12.99 inches/330 mm.

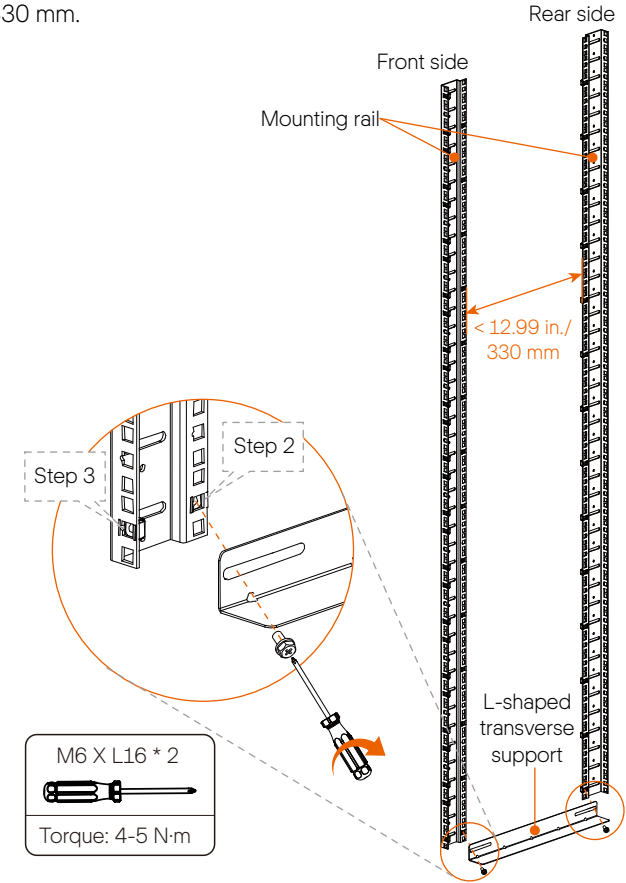

Note!

The two location holes on the L-shaped Transverse Support are long, please attach the screws at the end of holes near mounting rail.

Step 4. After all L-shaped Transverse Support are secured,

- ① Attach the assembled Mounting Rails into the cabinet.
- ② Fix the assembled Mounting Rails on Fix Rail by using 4 screws (delivered with the cabinet), and correctly insert and tighten 2 screws into the 4th and 5th location holes near the front side, and 2 screws into the 1st and 2nd holes near rear side (Tighten: 4-6 N·m).

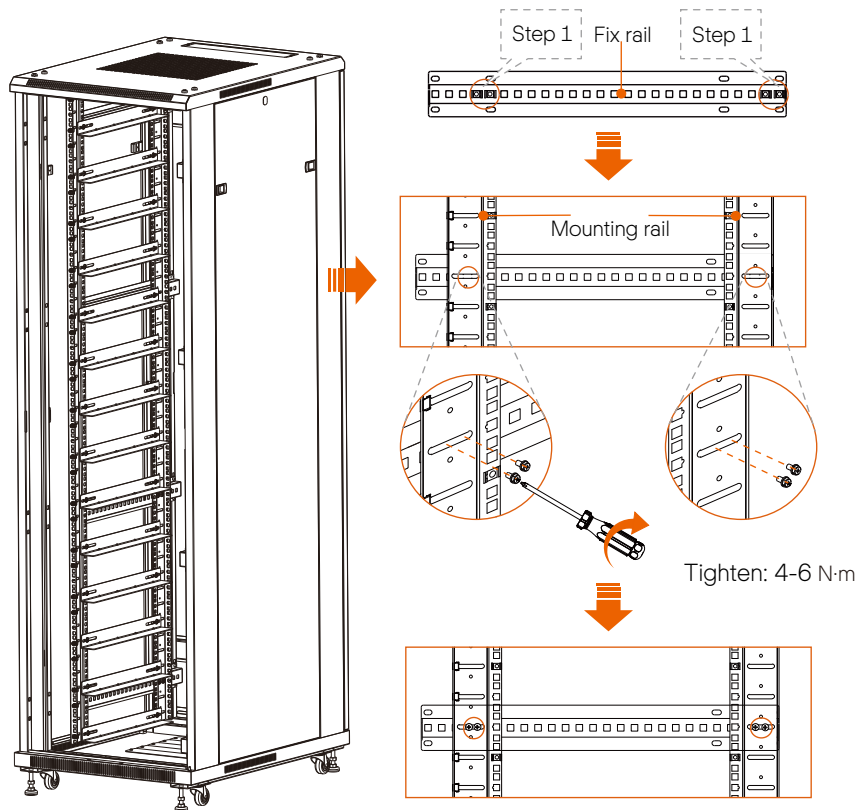

Note!

- The cassette nuts must be inserted before installing the assembled mounting rails.
- Please make sure that the four mounting rails are at the same level.
- The screws to fasten the mounting rail and fix rail are delivered with the cabinet. Four screws shall be attached and tightened per fix rail. Regarding the screw position, please follow the step on the page 32.
- Please ensure that heavy duty castors are tight and firm, and make sure that the adjustable feet are fairly close to the ground
- Please prevail in kind.

Step 5. Place battery modules into the cabinet, and correctly insert and tighten M6 screws (X 4) (Torque: 4-6 N·m)

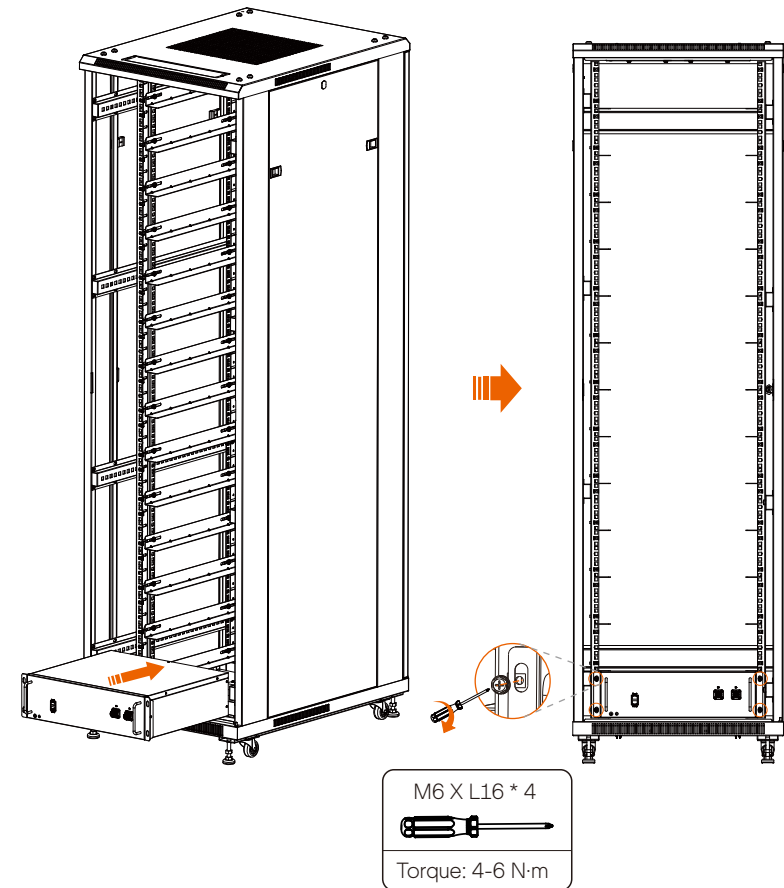

Note!

Please prevail in kind.

Step 6. Repeat step 5 until BMS has been put into the cabinet. The figure after finishing installation is as follows.

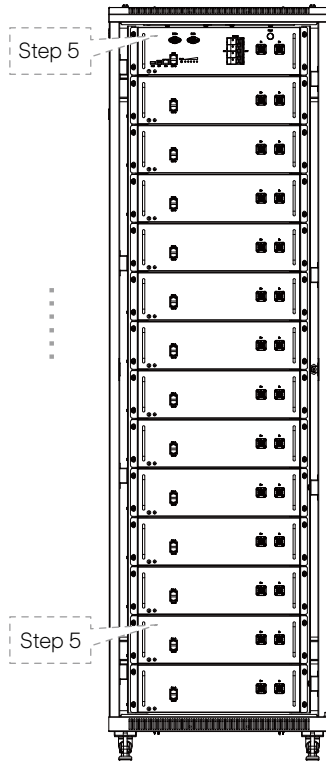

■ Wiring

After installation, connect a battery module to another battery (or BMS), and BMS to inverter.

- Battery module to battery module (or BMS)
Communication cable (1 pc), power cable (1 pc) and ground wire (1 pc) are provided in our packing list.



Communication cable: there are two registered jacks at both ends; one connects to Com-A of a battery module, and the other connects to Com-B of the neighboring battery module (or COMM of BMS).

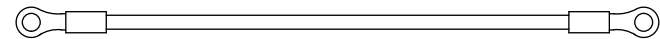

Ground wire: there are two terminals at both ends; one connects to a grounding point of a battery module; and the other connects to grounding point of the neighboring battery module or BMS.

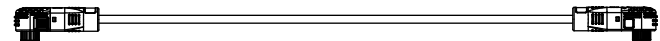

Power cable: there are two terminals with the same function at both ends; a power cable in the packing list of battery module, one end connects to B+ of a battery module, and the other connects to B- of the neighboring battery module (or B- of BMS). A power cable in the packing list of BMS, one end connects B+ of BMS and the other connects B- of a battery module at the bottom of the rack.

⚠ Caution!

Press and hold the “Lock Button” while unplugging the power cable. Otherwise, it cannot be pulled out.

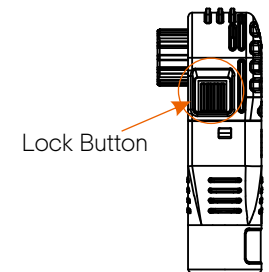

Connect cables between battery modules, and battery to BMS. See figure below.

- Battery module to neighboring battery module:
Power cable: "B+" port to "B-" port;
Communication cable: "Com-A" port to "Com-B" port;
Grounding cable: Grounding port to grounding port.
- Battery module to the BMS:
Power cable: "B-" port of the battery to "B+" of the BMS;
Communication: "Com-A" port of the battery to "Com-B" port of the BMS;
Grounding cable: Grounding port of the battery to grounding port of the BMS.

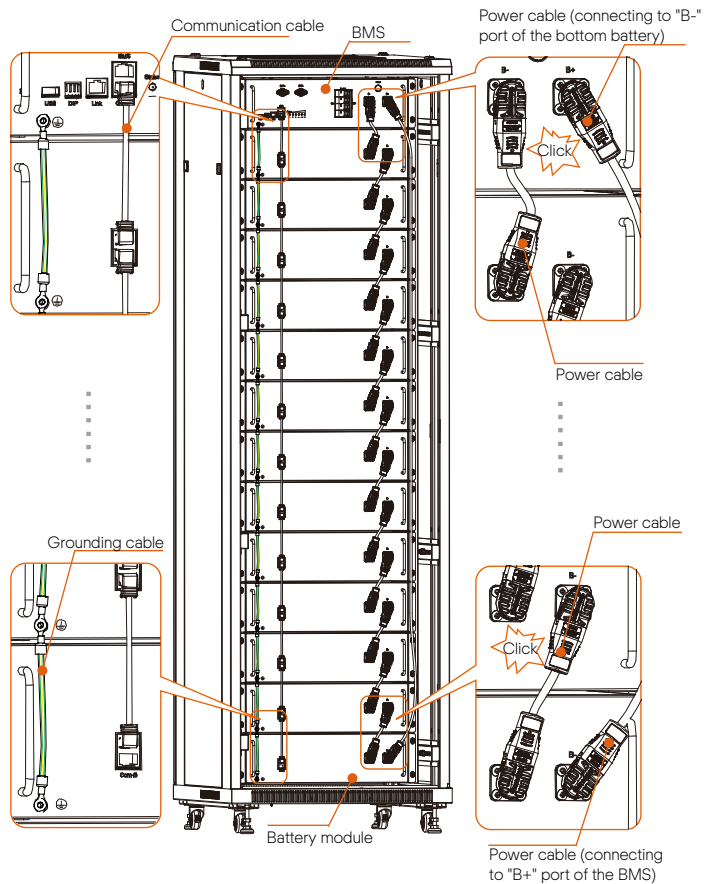

Note!

- Press and hold the "Lock button" while unplugging the power cable. Otherwise, it cannot be pulled out.
- Don't violently remove the power cables when they are locked.

- BMS to Inverter

Note!

The connector connecting to inverter from BMS is delivered with the inverter, for details, please refer to the inverter's User Manual.



Power cable (black): Connect BAT- of BMS to BAT- of inverter



Power cable (red): Connect BAT+ of BMS to BAT+ of inverter

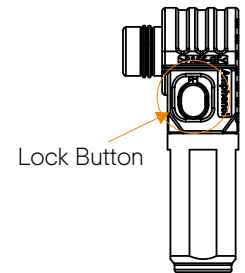

Caution!

Press and hold the "Lock Button" while unplugging the power cable. Otherwise, it cannot be pulled out.

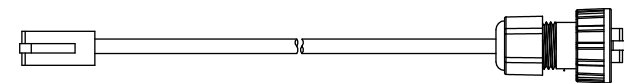

Communication cable: Connecting BMS's BMS and the inverter's BMS

■ Making a BMS communication cable

If users want to make a BMS communication cable or a BMS communication cable is required to be made before wiring, to ensure normal operation of BMS and inverter, please read the following carefully.

The specific definition of the communication cable is shown as follows:

Sequence	1	2	3	4	5	6	7	8
BMS	/	GND	/	BMS_H	BMS_L	/	A1	B1

The wire order of the communication cable is as follows:

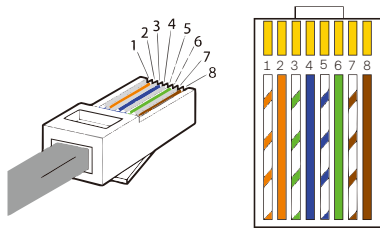

- 1) Orange stripes on white
- 2) Orange
- 3) Green stripes on white
- 4) Blue
- 5) Blue stripes on white
- 6) Green
- 7) Brown stripes on white
- 8) Brown

Note!

The BMS communication cable shall have a shield layer.

Connect cables between BMS and inverter. See figure below.

- BMS to inverter:
Power cable: "BAT+" port to "BAT+" port;
Communication cable: "BMS" port to "BMS" port;
Grounding cable: Grounding port to grounding port.

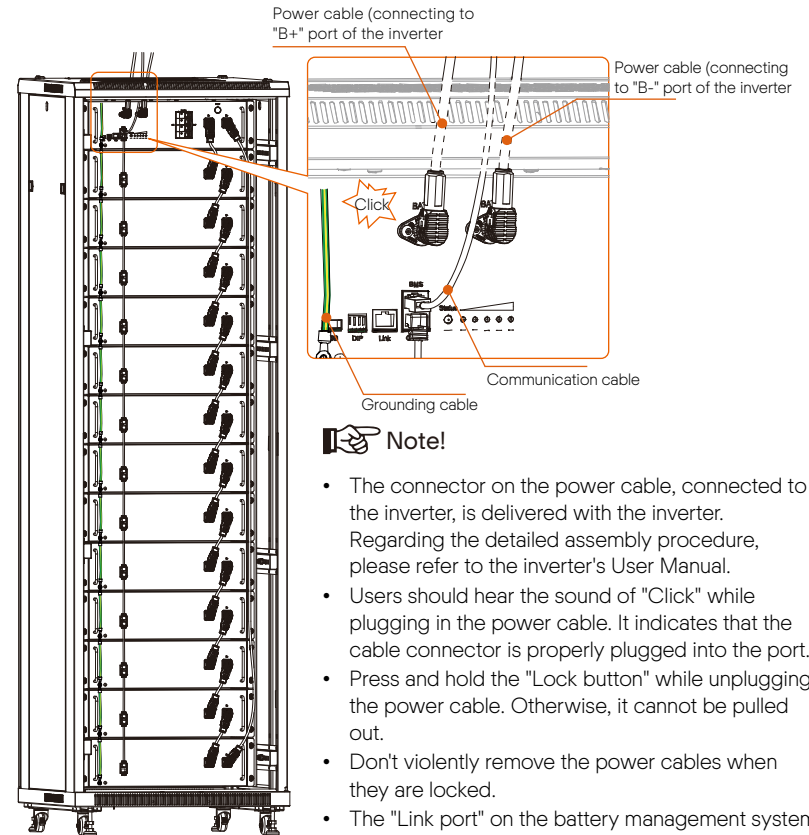

Note!

- The connector on the power cable, connected to the inverter, is delivered with the inverter. Regarding the detailed assembly procedure, please refer to the inverter's User Manual.
- Users should hear the sound of "Click" while plugging in the power cable. It indicates that the cable connector is properly plugged into the port.
- Press and hold the "Lock button" while unplugging the power cable. Otherwise, it cannot be pulled out.
- Don't violently remove the power cables when they are locked.
- The "Link port" on the battery management system (BMS) is for parallel connections only. Don't use it for any other purposes.

After completing wiring, these cable shall be through the threading hole on the caber plank.

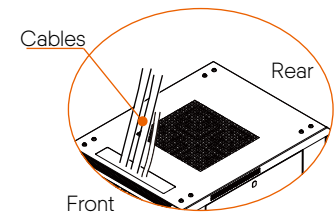

6 Commissioning

6.1 DIP Switch

The following figure is DIP switch, and it is equipped on BMS.

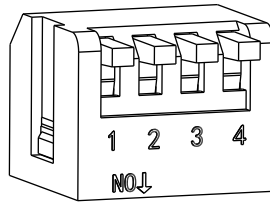

	Description
DIP switch 1	A reserved function
DIP switch 2	A reserved function
DIP switch 3	A reserved function
DIP switch 4	Terminal resistance Note: 1. The DIP switch 4 shall be flipped down (open the circuit) when connecting BMS to inverter; 2. In case of parallel connection, only shall the DIP switch 4 on the last BMS be flipped down (open the circuit), and the DIP switch 4 on the rest of BMS shall be flipped up (close the circuit).

The DIP switch 4 is pressed at the factory settings.



Note!

To adjust the DIP switch, a small flat-head screwdriver shall be prepared by users themselves.

6.2 Commissioning

Before commissioning, please check to ensure that, the installed battery modules are the same model battery module, and all the ground wires, power cables and communication cables are connected.

■ Power ON

After finishing wiring,

1. Turn the Breaker on;
2. Press the POWER button for 5 sec, to start system. See figure below.

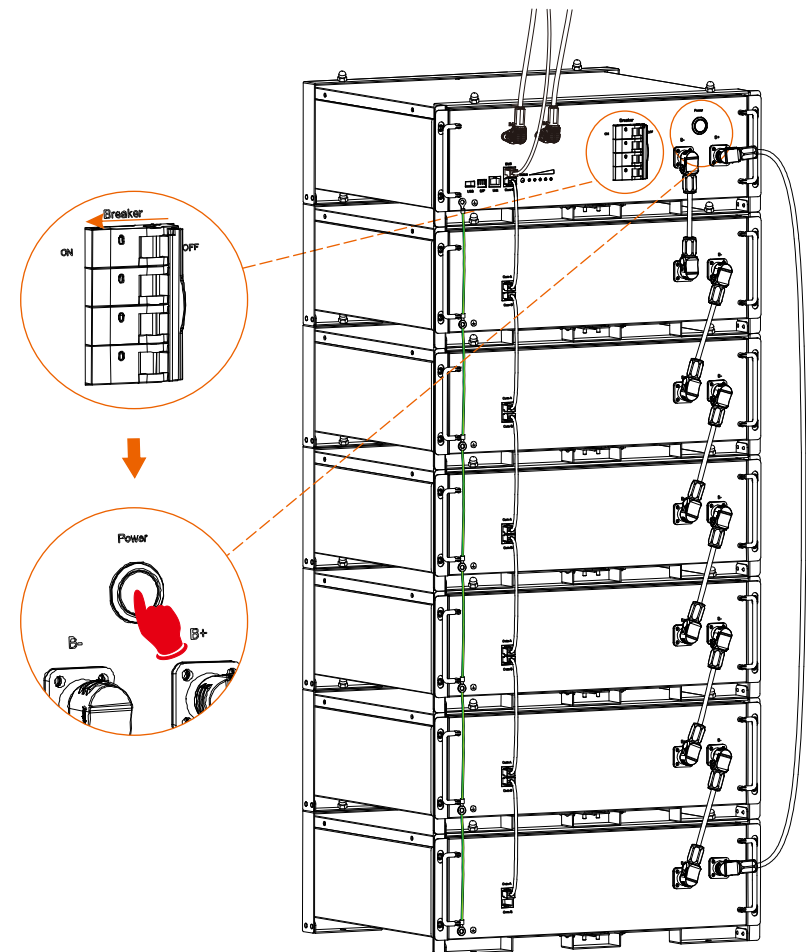

Note!

- Frequently pressing the POWER button may cause a system error.
- Wait at least 10 seconds after pressing the POWER button prior to making another attempt.

In case of pressing and holding POWER button, there are two circumstances as below:

1. Press and hold POWER button for more than 5 sec but less than 20 sec, the system will enter a startup mode of inverter.
2. Press and hold POWER button for more than 20 sec, the system will enter the Black Start.

Our equipment can provide Black Start capability, meaning that our energy storage inverter and battery can continue to run even if the power grid and photovoltaic panel are out of service. The startup procedure for Black Start is as follows:

- In case of pressing and hold the POWER button for less than 20 sec, the status light will flash green light for 1 sec and then turn off for 4 sec, with a period of 5 sec.
- After pressing and holding the POWER button for 20 sec, the status light will come on solid green light, and the SOC power indicators will flash as follows:
 - 1) The 3rd indicator (from left to right) flashes yellow light, and the remaining indicators are off;
 - 2) The 2nd and 4th indicators flash yellow light, and the remaining indicators are off;
 - 3) The 1st and 5th indicators flash yellow light, and the remaining indicators are off;
 - 4) All the power indicators are off. The whole process will last for 0.4 sec. At this point, it will show its current battery charge and enter the Black Start status.

Note!

We do not recommend the use of Black Start as it may cause the port to be charged, resulting in an electric shock.

Power Off

1. Turn the Breaker off;
2. Press and hold the POWER button for more than 1 sec. At this point, the status light will remain on solid green light, and the power indicator will flash green light from left to right, and then all lights are off.

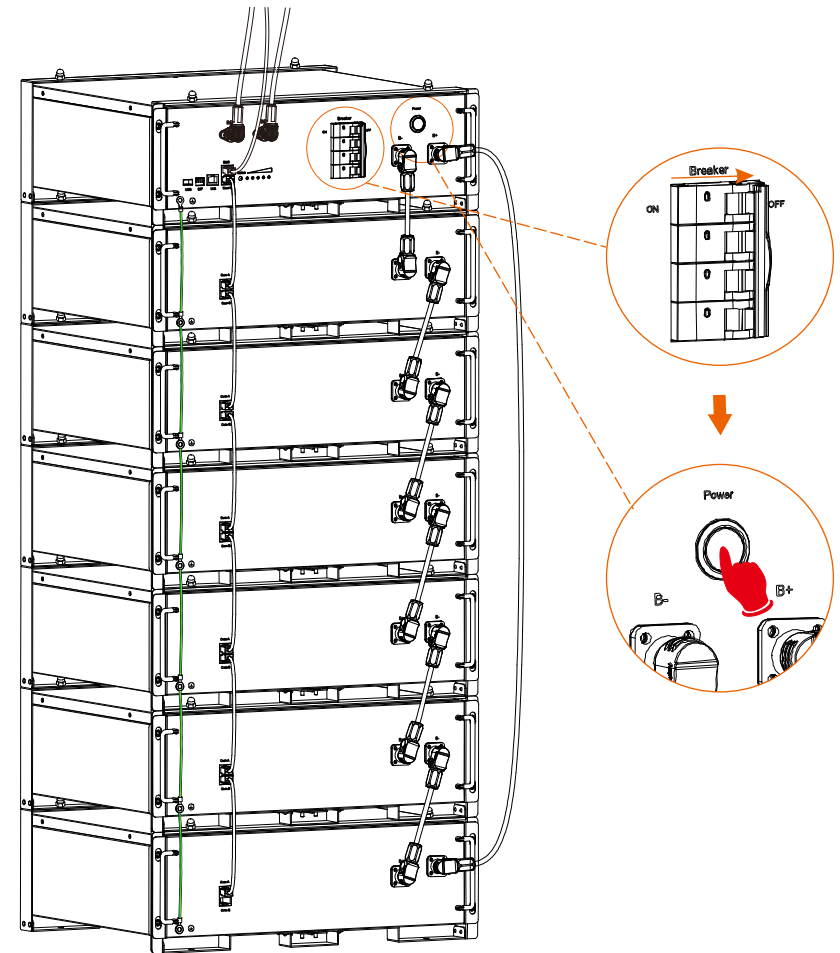
**Note!**

The startup and shutdown operation procedures of these two installation modes (incl. rack and cabinet) are the same.

6.3 Status Indicators

6.3.1 BMS (TBMS-MCR0800)

The power indicators show the current battery percentage, with details as show in the figure below.

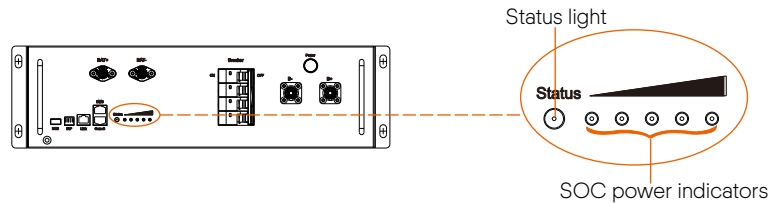

	Description
Startup	After pressing the POWER button, the status light will flash yellow light every 0.1 seconds.
Shutdown	After pressing and holding the POWER button for more than 1 second, the status light will remain on solid green light, and the SOC power indicators will flash yellow light from left to right, and then all lights are off.
Standby	The status light will remain on solid green light. At this point, the SOC power indicators flash green light for 1 second, and then turn off for 4 seconds.
Charging	The status light will remain on solid green light. Regarding the SOC power indicators will flash yellow light based on their actual remaining capacity.
Discharging	The status light will remain on solid green light, and at the meantime, the SOC power indicators will flash yellow light for 1 second and turn off for 4 seconds based on their actual remaining capacity.
Fault	In case of failure, the status light will remain on solid red light for 10 mins, and then such red light will flash for 1s and then turn off for 4 sec.
Warning	In case of alarm, the status light will flash yellow light for 1 sec, and then turn off for 4 sec.
Black Start	1. In case of pressing and hold the POWER button for less than 20 sec, the status light will flash green light for 1 sec and then turn off for 4 sec, with a period of 5 sec. 2. After pressing and holding the POWER button for 20 sec, the status light will come on solid green light, and the SOC power indicators will flash as follows: 1) The 3rd indicator (from left to right) flashes yellow light, and the remaining indicators are off; 2) The 2nd and 4th indicators flash yellow light, and the remaining indicators are off; 3) The 1st and 5th indicators flash yellow light, and the remaining indicators are off; 4) All the power indicators are off. The whole process will last for 0.4 sec.

SOC power indicators during charging

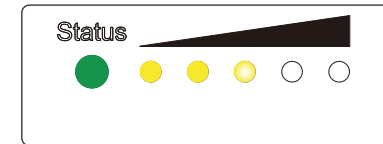

When the battery level is at 60%, the SOC power indicators will show as follows:

- 1.The first two SOC power indicators (20% and 40%) remain on solid green light.
- 2.The third SOC power indicators (60%) will flash yellow light.
- 3.The remaining SOC power indicator (80% and 100%) will be off

SOC power indicators during discharging



When the battery level is at 60%, the SOC power indicators will show as follows:

- 1.The first three SOC power indicators (20%, 40%, and 60%) will flash yellow light;
- 2.The remaining SOC power indicator (80% and 100%) will be off.

7 Troubleshooting

7.1 Troubleshooting

Check the previous indicators to determine the status of the T-BAT system. In case of the following circumstances, e.g. voltage or temperature exceeds a limit, a warning state will be triggered.

T-BAT system's BMS periodically reports its operating state to the inverter. When the T-BAT system exceeds the specific limits, it will enter into a warning state.

When a warning is reported, the inverter will stop work immediately.

Determine the cause of warning by using the monitoring software on the inverter. The possible error messages are as follows:

Error	Description	Diagnosis & Solution
BMS_External_Err	External fault of BMS	Unable to establish communication with inverter. <ul style="list-style-type: none"> Restart BMS; Contact the Company's after-sales personnel.
BMS_Internal_Err	Internal fault of BMS	Unable to establish communication among batteries. <ul style="list-style-type: none"> Restart BMS; Check if the connection among batteries is normal; Contact the Company's after-sales personnel.
BMS_OverVoltage	BMS overvoltage	Overvoltage of single battery. <ul style="list-style-type: none"> Contact the Company's after-sales personnel.
BMS_LowerVoltage	BMS undervoltage	Undervoltage of single battery. <ul style="list-style-type: none"> Battery is forced to charge through inverter; Contact the Company's after-sales personnel.
BMS_ChargeOverCurrent	Overcurrent charging of BMS	Overcurrent charging of BMS. <ul style="list-style-type: none"> Restart BMS; Contact the Company's after-sales personnel.
BMS_DischargeOverCurrent	Discharge overcurrent of BMS	Discharge overcurrent of BMS. <ul style="list-style-type: none"> Restart BMS; Contact the Company's after-sales personnel.

Error	Description	Diagnosis & Solution
BMS_TemHigh	High temperature of BMS	The temperature of BMS is too high. <ul style="list-style-type: none"> Let BMS cool down to normal temperature and restart; Contact the Company's after-sales personnel.
BMS_TemLow	Low temperature of BMS	The temperature of BMS is too low. <ul style="list-style-type: none"> Warm up BMS and restart; Contact the Company's after-sales personnel.
BMS_CellImbalance	Cell imbalance of BMS	Inconsistency of battery. <ul style="list-style-type: none"> Restart BMS; Contact the Company's after-sales personnel.
BMS_Hardware_Protect	Hardware protection of BMS	Hardware protection of BMS. <ul style="list-style-type: none"> Restart BMS; Contact the Company's after-sales personnel.
BMS_Circuit_Fault	Circuit fault	Circuit fault of BMS. <ul style="list-style-type: none"> Restart BMS; Contact the Company's after-sales personnel.
BMS_Insulation_Fault	Insulation fault	Insulation fault of BMS. <ul style="list-style-type: none"> Restart BMS; Contact the Company's after-sales personnel.
BMS_VoltSensor_Fault	Voltage sensor fault	Voltage sampling fault of BMS. <ul style="list-style-type: none"> Restart BMS; Contact the Company's after-sales personnel.
BMS_TempSensor_Fault	Temperature sensor fault	Temperature sampling fault of BMS. <ul style="list-style-type: none"> Restart BMS; Contact the Company's after-sales personnel.
BMS_TempSensor_Fault	Current sensor fault	Current sampling fault of BMS. <ul style="list-style-type: none"> Restart BMS; Contact the Company's after-sales personnel.
BMS_Relay_Fault	Relay fault	Relay contact adhesion fault of BMS. <ul style="list-style-type: none"> Restart BMS; Contact the Company's after-sales personnel.

Error	Description	Diagnosis & Solution
BMS_Type_Unmatch	BMS type matching error	Different type of BMS. <ul style="list-style-type: none"> Restart BMS; Contact the Company's after-sales personnel.
BMS_Version_Unmatch	BMS version matching error	Different type of BMS. <ul style="list-style-type: none"> Restart BMS; Contact the Company's after-sales personnel.
BMS_Manufacturer_Unmatch	BMS manufacturer matching error	Different type of BMS. <ul style="list-style-type: none"> Restart BMS; Contact the Company's after-sales personnel.
BMS_SW&HW_Unmatch	Software and hardware mismatch error of BMS	Different type of BMS. <ul style="list-style-type: none"> Restart BMS; Contact the Company's after-sales personnel.
BMS_M&S_Unmatch	BMS and battery module mismatch error	Different type of BMS. <ul style="list-style-type: none"> Restart BMS; Contact the Company's after-sales personnel.
BMS_CR_Unresponsive	Charging request not responded	Inverter does not respond the charging request. <ul style="list-style-type: none"> Restart BMS or inverter; Contact the Company's after-sales personnel.
S_Software_Protect	Software protection of battery module	Software protection of battery module. <ul style="list-style-type: none"> Restart BMS; Contact the Company's after-sales personnel.
BMS_536_Fault	536 fault of BMS	BMS voltage sampling fault. <ul style="list-style-type: none"> Restart BMS; Contact the Company's after-sales personnel.
BMS_Selfchecking_Fault	Self-test fault of BMS	Self-test fault of BMS. <ul style="list-style-type: none"> Restart BMS; Contact the Company's after-sales personnel.
BMS_Tempdiff_Fault	Temperature different fault	BMS temperature varies greatly. <ul style="list-style-type: none"> Restart BMS; Contact the Company's after-sales personnel.

Error	Description	Diagnosis & Solution
BMS_Break	Disconnection fault of BMS	BMS sampling fault. <ul style="list-style-type: none"> Restart BMS; Contact the Company's after-sales personnel.
BMS_Flash_Fault	Flash fault of BMS	Memory chip fault. <ul style="list-style-type: none"> Restart BMS; Contact the Company's after-sales personnel.
BMS_Precharge_Fault	BMS precharge fault	External short circuit of BMS. <ul style="list-style-type: none"> Check the external connection and restart BMS; Contact the Company's after-sales personnel.
BMS_AirSwitch_Break	Disconnection of switch break of BMS	Disconnection of switch break of BMD. <ul style="list-style-type: none"> Restart BMS; Contact the Company's after-sales personnel.

8 Decommissioning

8.1 Dismantling the Battery

Shutting down the battery unit

- Disconnect the cables between the BMS and inverter;
- Disconnect the series wiring terminal on the battery;
- Disconnect the cables.

8.2 Packing

Pack the BMS and battery modules in the original packaging.

If the original packaging is no longer available, use an equivalent carton or box that meets the following requirements:

- Suitable for loads over 154.32 lbs/70.00 kg;
- Properly closed and sealed.

9 Maintenance

- If the ambient temperature for storage is $-4^{\circ}\text{F}\sim 86^{\circ}\text{F}/-20^{\circ}\text{C}\sim 30^{\circ}\text{C}$, recharge the batteries at least once every 12 months.
- If the ambient temperature for storage is $86^{\circ}\text{F}\sim 122^{\circ}\text{F}/30^{\circ}\text{C}\sim 50^{\circ}\text{C}$, recharge the batteries at least once every 6 months.
- If the battery(ies) has(have) not been used for more than 9 months, the battery(ies) must be charged to at least SOC 50 % each time.
- For the first installation, the interval among manufacture dates of batteries shall not exceed 3 months.
- If a battery is replaced or added for capacity expansion, each battery's SOC should be consistent. The max. SOC difference should be between $\pm 5\%$.
- If users want to increase their battery system capacity, please ensure that the SOC of the existing system capacity is about 40%. The manufacture date of the new battery shall not exceed 6 months; in case of exceeding 6 months, please charge the new battery to around 40%.
- In the allowable range, the relative humidity range should be between 5% and 95% RH.

10 Disclaimer

Triple Power protects this product under warranty when it is installed and used as listed in this manual. Violation of the installation procedure or use of the product in any way not described in this manual will immediately void all warranties on the product.

Triple Power does not provide warranty coverage or assume any liability for direct or indirect damages or defects that result from the following causes:

- Force majeure (flooding, lightning strike, overvoltage, fire, thunderstorm, flooding etc.);
- Improper or noncompliant use;
- Improper installation, commissioning, start up or operation (contrary to the guidance detailed in the installation manual supplied with each product);
- Inadequate ventilation and circulation resulting in minimized cooling and natural air flow;
- Installation in a corrosive environment;
- Damage during transportation;
- Unauthorized repair attempts;
- Failure to adequately maintain the equipment. An on-site inspection by a qualified technician is possible following 120 months of continuous use. Warranty claims made beyond 120 months from date of commissioning may be declined if it cannot be demonstrated that the equipment has been adequately maintained;
- External influence including unusual physical or electrical stress (power failure surges, inrush current, etc.);
- Use of an incompatible inverter or devices;
- Connect to other brands of inverter without authority from our company.

Warranty Registration Form



For Customer (Compulsory)

Name Country

Phone Number Email

Address

State Zip Code

Product Serial Number

Date of Commissioning

Installation Company Name

Installer Name Electrician License No.

For Installer

Module (If Any)

Module Brand

Module Size(W)

Number of String Number of Panel Per String

Battery (If Any)

Battery Type

Brand

Number of Battery Attached

Date of Delivery Signature

Please visit our warranty website: <https://www.solaxcloud.com/#/warranty> to complete the online warranty registration or use your mobile phone to scan the QR code to register.

For more detailed warranty terms, please visit SolaX official website: www.solaxpower.com to check it.





PLEASE REGISTER THE WARRANTY IMMEDIATELY AFTER INSTALLATION!
GET YOUR WARRANTY CERTIFICATE FROM SOLAX!
KEEP YOUR INVERTER ONLINE & WIN SOLAX POINTS!

1

Open your camera app and point your device at the QR code



2

Wait for the camera to recognize the QR code



3

Click banner or notification when it appears on the screen



4

Warranty registration page will be loaded automatically

